

Be imaginative because anything is possible. Think of yourself as workers



children



families



others

Add the likelihood codes

++ very likely could happen any time

+ likely could happen sometime

- unlikely could happen but very rarely

-- very unlikely could happen, but probably never will

Leaving gates open

Allow children they don't own to leave the centre

Leaving other children car, hot car, or car moving

Car stolen with other children in it. (Has happened)

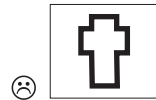

Kill or cause permanent disability

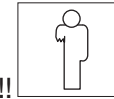

Long term illness or serious injury

Taken their child into the kitchen child accesses knives, hot water, dish washing powder.

Leaving children in the room unattended



OHS New Families

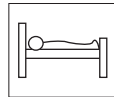

Medical attention and several days off work

Leaving children in the room unattended

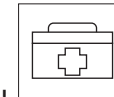

First aid needed

Leaving children in the room unattended

Children swing on the gate

Talking to staff and distracting them from supervising when collecting children in the afternoon

*Older children access cupboards
Younger children access things in the centre, beads, craft material, etc*

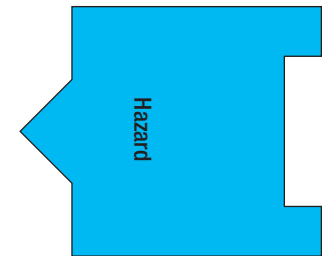



Add the likelihood codes

++ very likely could happen any time

+ likely could happen sometime

- unlikely could happen but very rarely

-- very unlikely could happen, but probably never will

Add the likelihood codes



Coloured toys on coloured mat in walkway. Parent in high heel shoes in a rush walks in and trips on toys and hits her head on book case and dies.

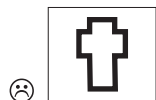

☹ Kill or cause permanent disability

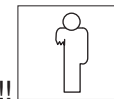

!!! Long term illness or serious injury



Mats, paths, trips falls

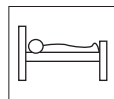

+ More likely medical here

!! Medical attention and several days off work

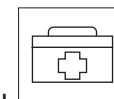

! First aid needed

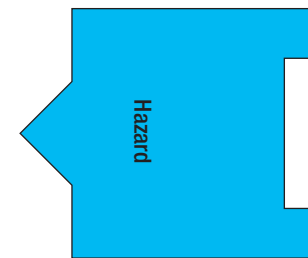



Add the likelihood codes

++ very likely could happen any time

+ likely could happen sometime

- unlikely could happen but very rarely

-- very unlikely could happen, but probably never will

Heavy items stacked incorrectly on shelf falling onto children.

- Don't forget to include:
- Tables
 - chairs
 - beds
 - book cases
 - out door play equipment
 - craft paint
 - children
 - deliveries of new toys and equipment
 - water bottles for coolers
 - photocopy paper
 - children chucking a tantrum

Moving play equipment

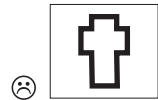

Kill or cause permanent disability

Children jumping to you from equipment

Placing children on your hips

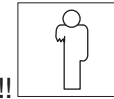

Long term illness or serious injury

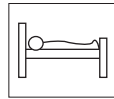

Medical attention and several days off work

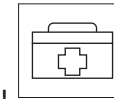

First aid needed

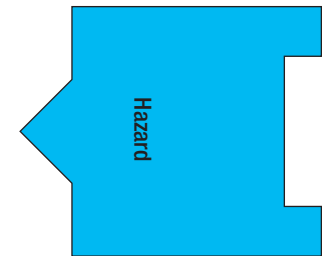

Be imaginative because anything is possible. Think of yourself as workers



children



families



others



Add the likelihood codes

++ very likely
could happen
any time

+ likely
could happen
sometime

- unlikely
could happen
but very rarely

-- very unlikely
could happen,
but probably
never will

*What can be used as a ladder
What is over 50 cm high
what is over 1m high
What is in the drop
zone of play equipment
that children could fall on first
before sofffall*

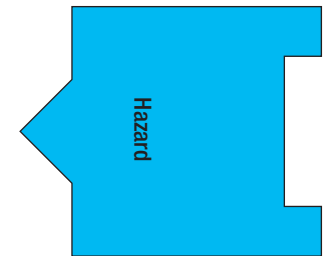
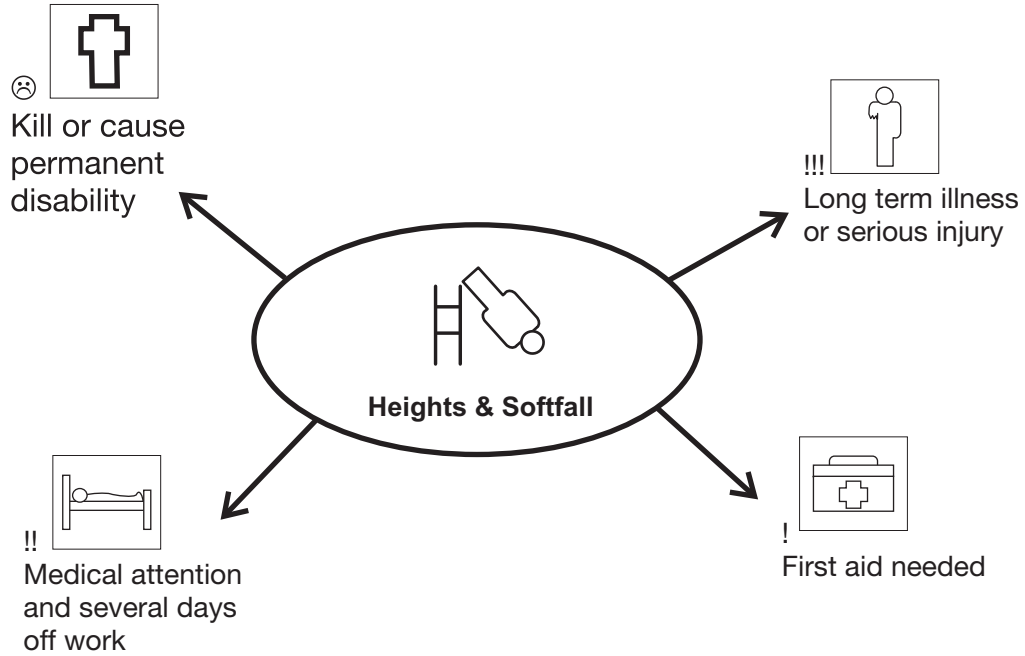

Be imaginative because anything is possible. Think of yourself as workers



children



families



others



Add the likelihood codes

++ very likely
could happen
any time

+ likely
could happen
sometime

- unlikely
could happen
but very rarely

-- very unlikely
could happen,
but probably
never will

*Fish tank cord
Computer cords
Back of computer
Power packs
Battery chargers
Lights*

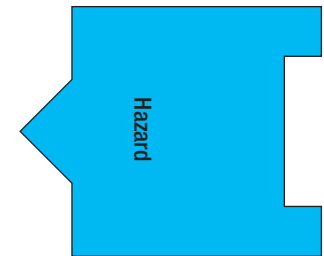
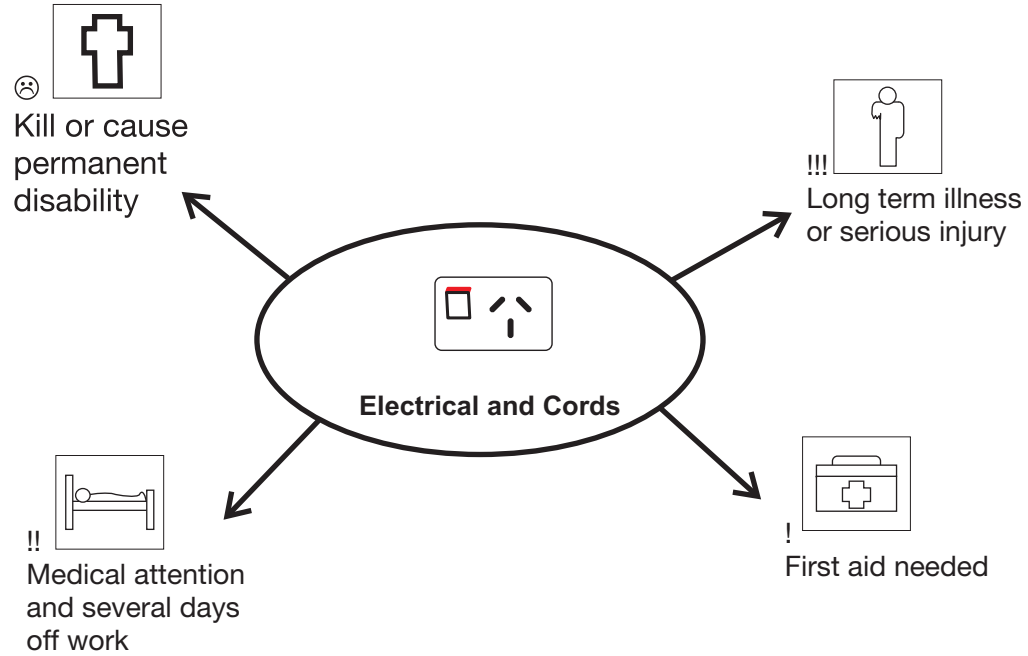



Add the likelihood codes

++ very likely
could happen
any time

+ likely
could happen
sometime

- unlikely
could happen
but very rarely

-- very unlikely
could happen,
but probably
never will

Can you move freely in the storage room?

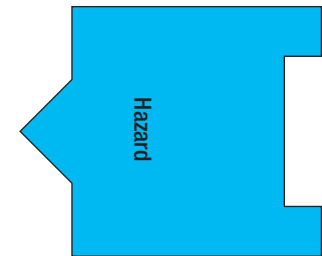
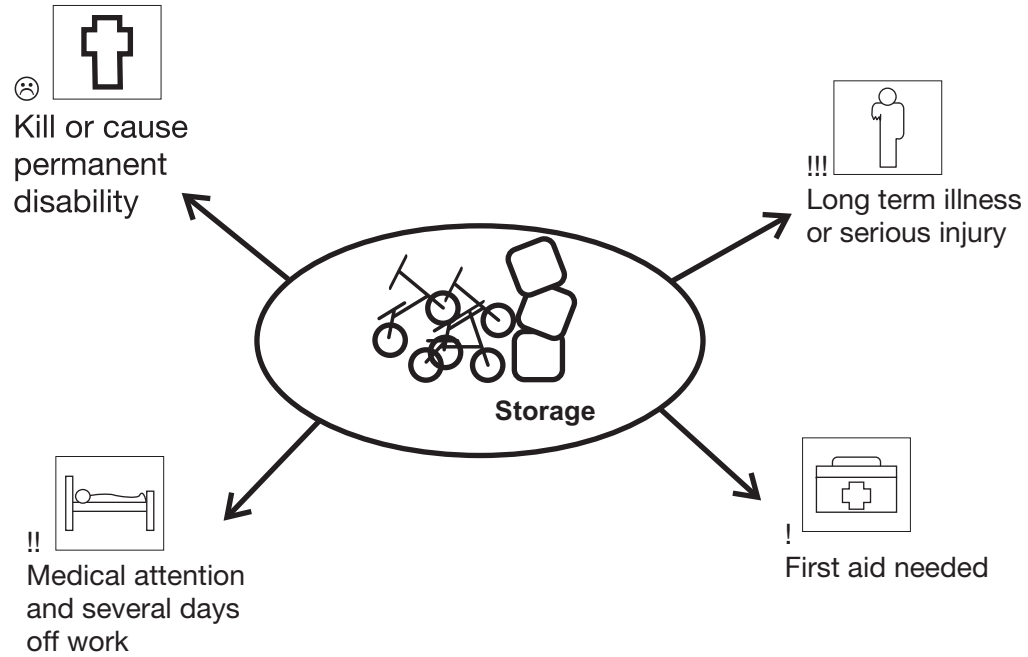



Add the likelihood codes

++ very likely could happen any time

+ likely could happen sometime

- unlikely could happen but very rarely

-- very unlikely could happen, but probably never will

Cherry tomatoes – a child in a Canberra centre choked and died on a cherry tomato.

Plastic cannot be removed from a child's wind pipe

Child died in Orange NSW from peanuts

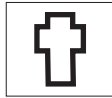

Kill or cause permanent disability

Coffee and Tea, 2 minute noodles
Hot water kettles

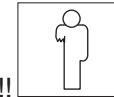

Long term illness or serious injury

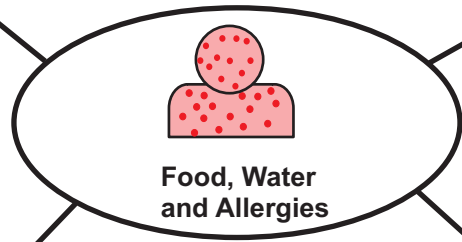

Food, Water and Allergies

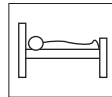

Medical attention and several days off work

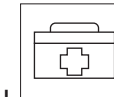

First aid needed

2 minute noodles burnt arm of child care worker getting them out of micro wave

3 children a day get admitted to hospitals from burns, mostly from hot water.

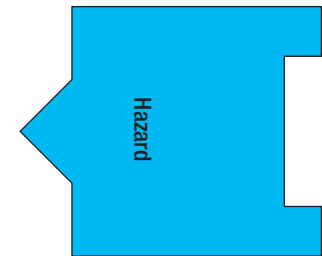

Be imaginative because anything is possible. Think of yourself as workers



children



families



others



Add the likelihood codes

++ very likely could happen any time

+ likely could happen sometime

- unlikely could happen but very rarely

-- very unlikely could happen, but probably never will

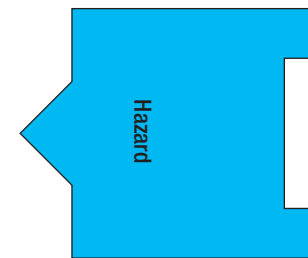
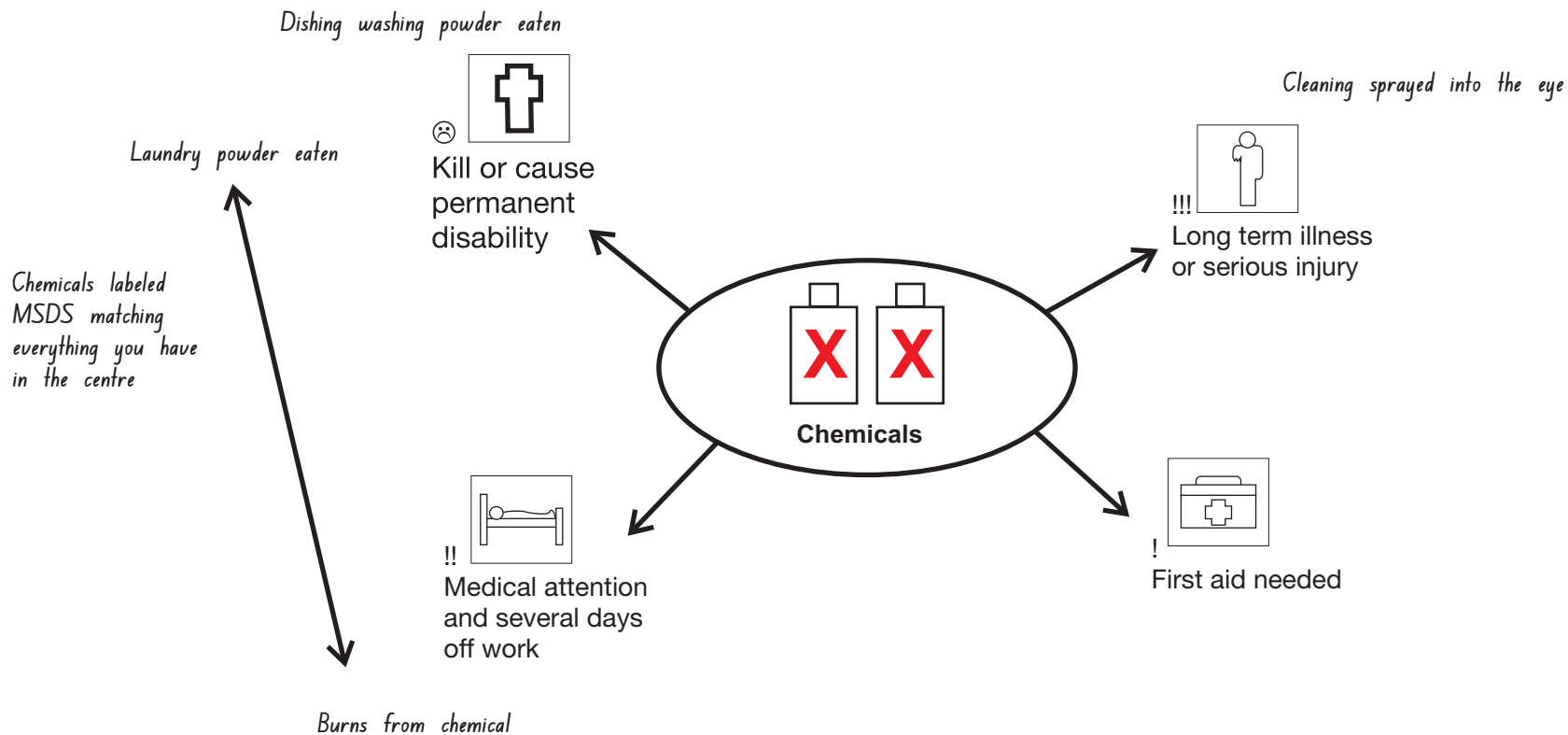

Be imaginative because anything is possible. Think of yourself as workers



children



families



others



Add the likelihood codes

++ very likely could happen any time

+ likely could happen sometime

- unlikely could happen but very rarely

-- very unlikely could happen, but probably never will

Skin Cancer

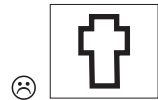

Kill or cause permanent disability

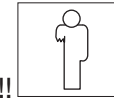

Long term illness or serious injury

Cords caught on play equipment from clothing



Clothing for Staff & Children

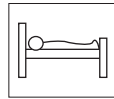

Medical attention and several days off work

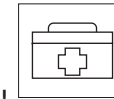

First aid needed

Sun burn

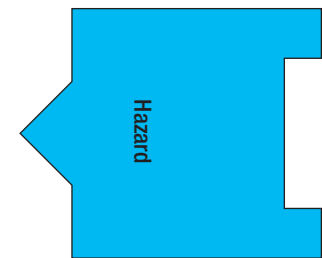

Be imaginative because anything is possible. Think of yourself as workers



children



families



others

Add the likelihood codes

++ very likely could happen any time

+ likely could happen sometime

- unlikely could happen but very rarely

-- very unlikely could happen, but probably never will

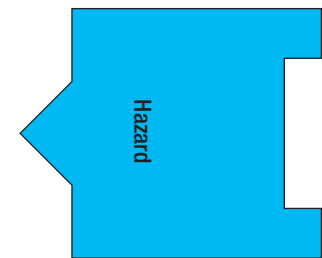
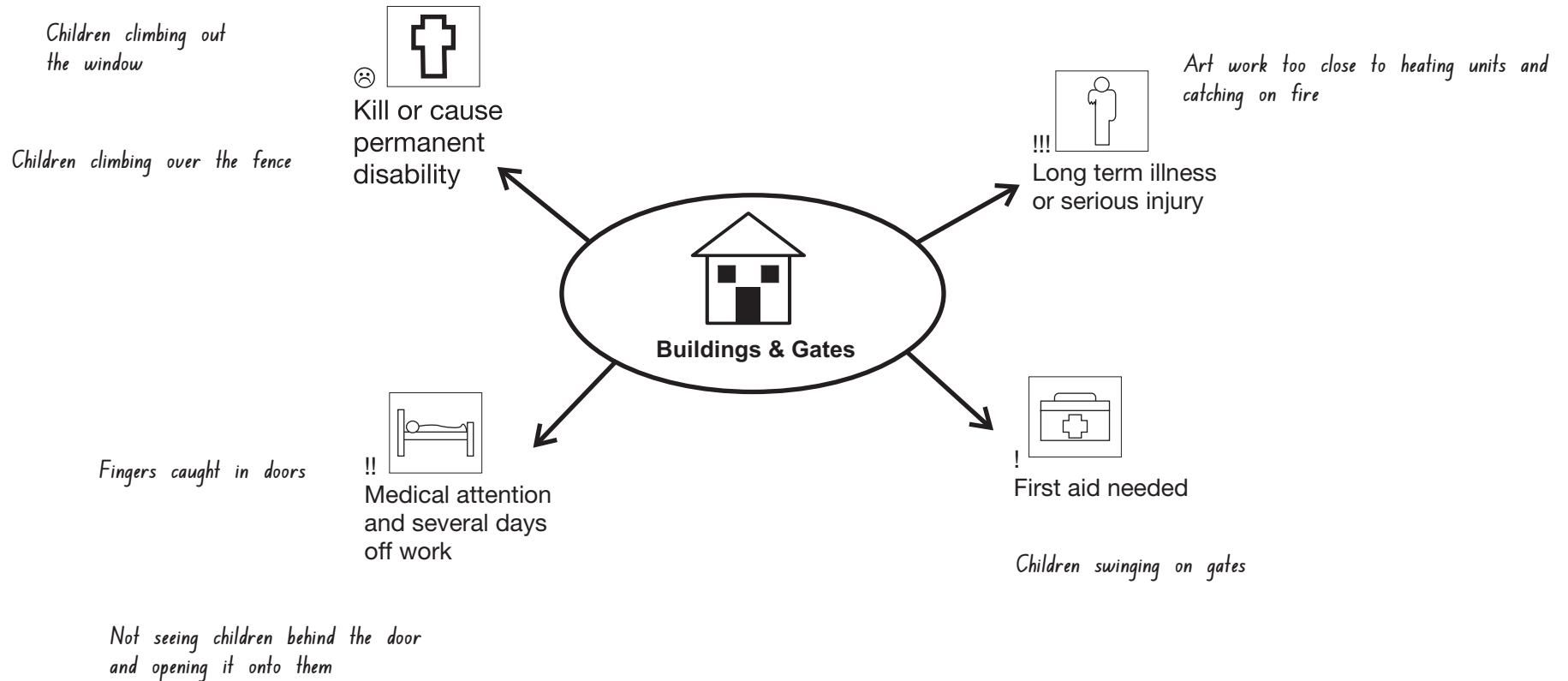



Add the likelihood codes

++ very likely could happen any time

+ likely could happen sometime

- unlikely could happen but very rarely

-- very unlikely could happen, but probably never will

Most injuries to a child in a centre is due to a lack of supervision

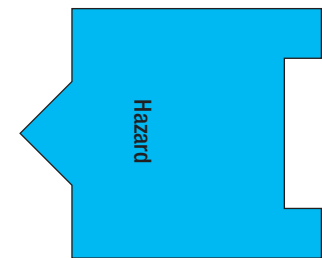
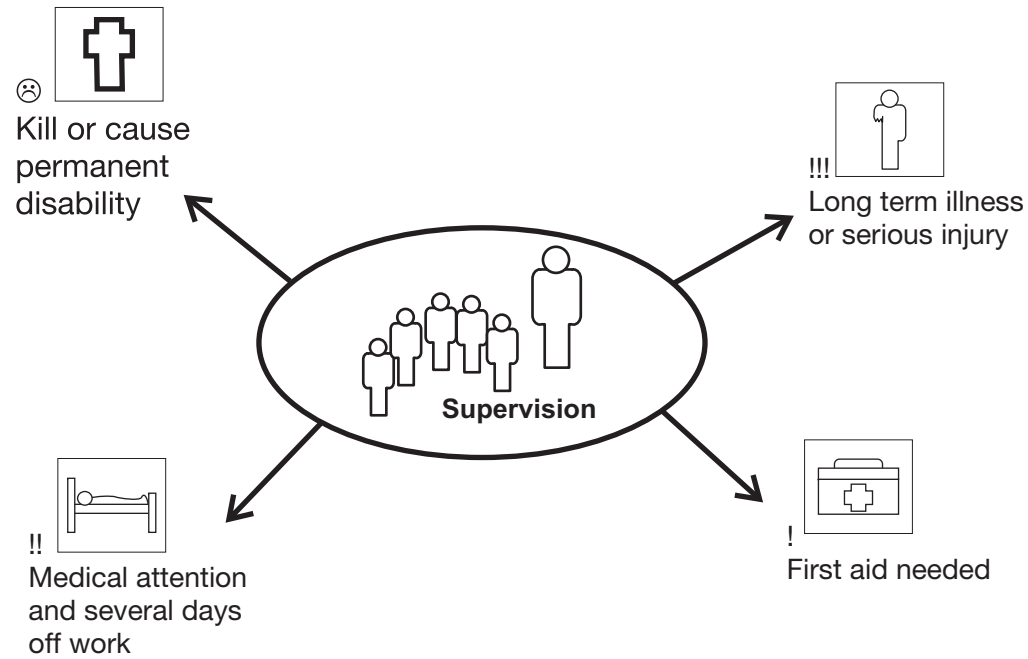



Add the likelihood codes

++ very likely
could happen
any time

+ likely
could happen
sometime

- unlikely
could happen
but very rarely

-- very unlikely
could happen,
but probably
never will

Moving cars

Hot Cars

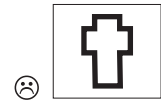

Kill or cause
permanent
disability

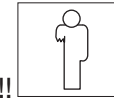

Long term illness
or serious injury

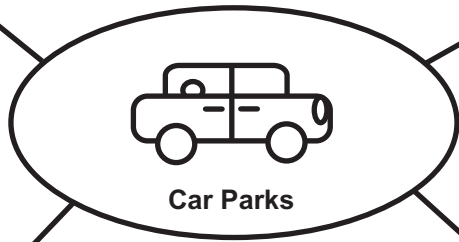

Car Parks

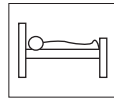

Medical attention
and several days
off work

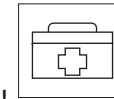

First aid needed

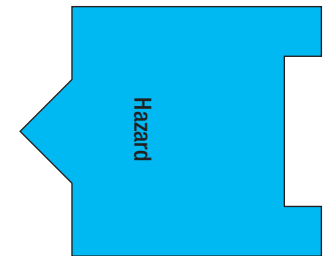

Be imaginative because anything is possible. Think of yourself as workers



children



families



others



Add the likelihood codes

++ very likely
could happen
any time

+ likely
could happen
sometime

- unlikely
could happen
but very rarely

-- very unlikely
could happen,
but probably
never will

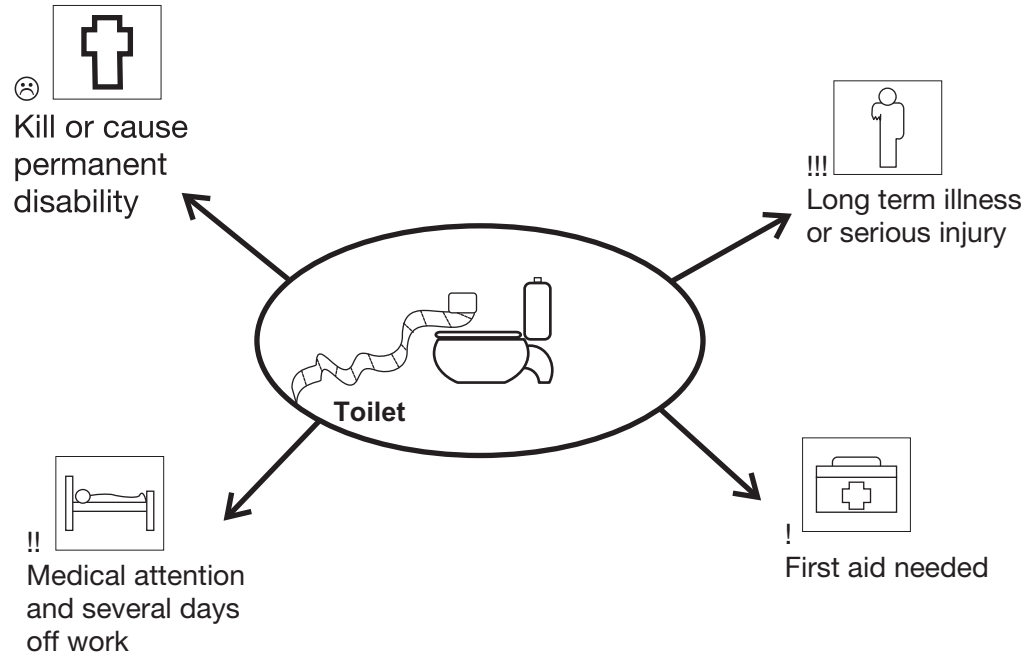

Disease spreading from poo.

Cross contamination ie Conjunctivitis

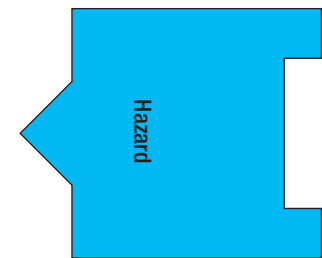

Be imaginative because anything is possible. Think of yourself as workers



children



families



others



Add the likelihood codes

++ very likely
could happen
any time

+ likely
could happen
sometime

- unlikely
could happen
but very rarely

-- very unlikely
could happen,
but probably
never will

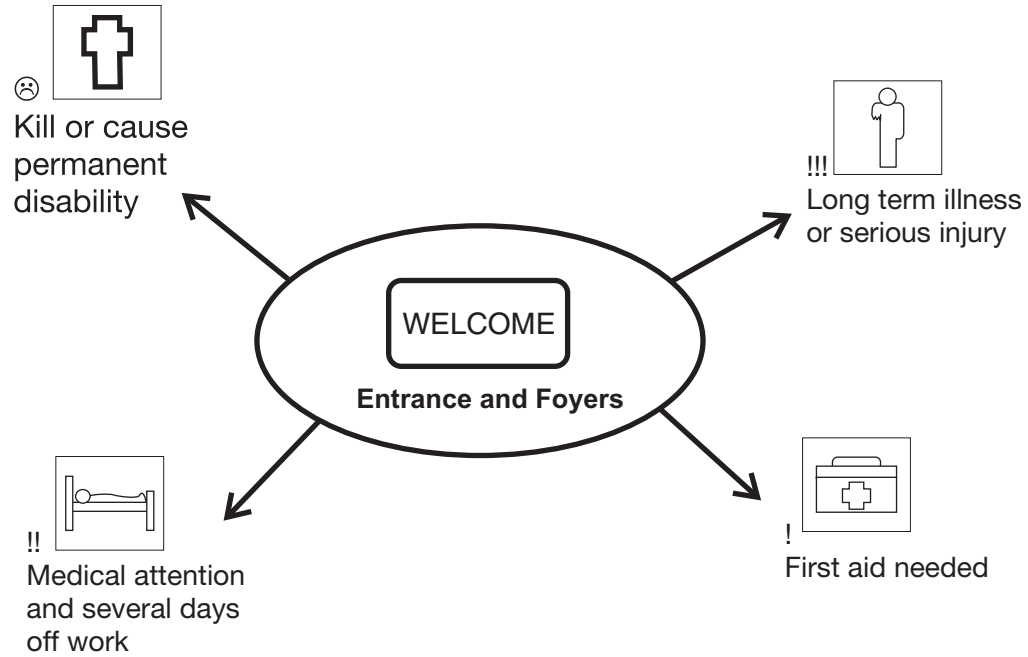

Poisonous office items such as liquid paper stored in the entrance areas

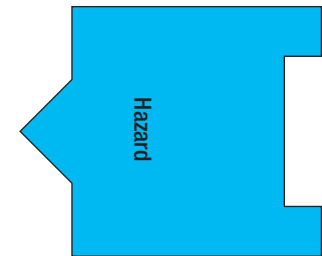

Be imaginative because anything is possible. Think of yourself as workers



children



families



others



Add the likelihood codes

++ very likely
could happen
any time

+ likely
could happen
sometime

- unlikely
could happen
but very rarely

-- very unlikely
could happen,
but probably
never will

Hot water from kettle

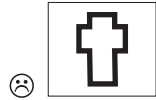

☹️
Kill or cause
permanent
disability

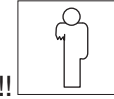

!!!
Long term illness
or serious injury

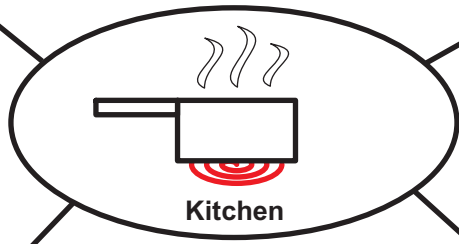

Kitchen

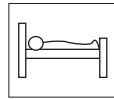

!!
Medical attention
and several days
off work

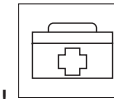

!
First aid needed

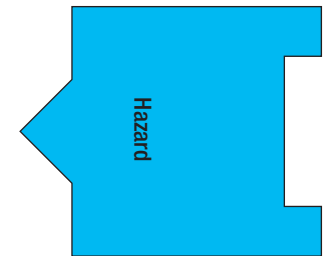

Be imaginative because anything is possible. Think of yourself as workers



children



families



others



Add the likelihood codes

++ very likely
could happen
any time

+ likely
could happen
sometime

- unlikely
could happen
but very rarely

-- very unlikely
could happen,
but probably
never will

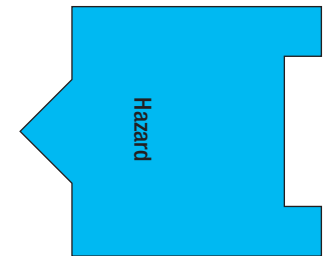
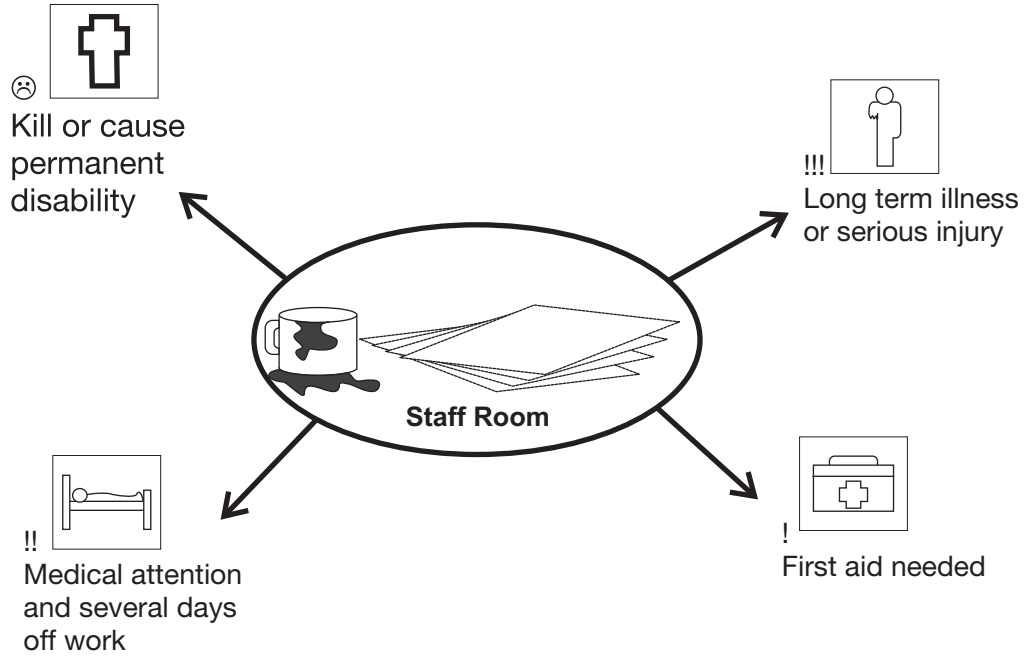

Be imaginative because anything is possible. Think of yourself as workers



children



families



others



Add the likelihood codes

++ very likely
could happen
any time

+ likely
could happen
sometime

- unlikely
could happen
but very rarely

-- very unlikely
could happen,
but probably
never will

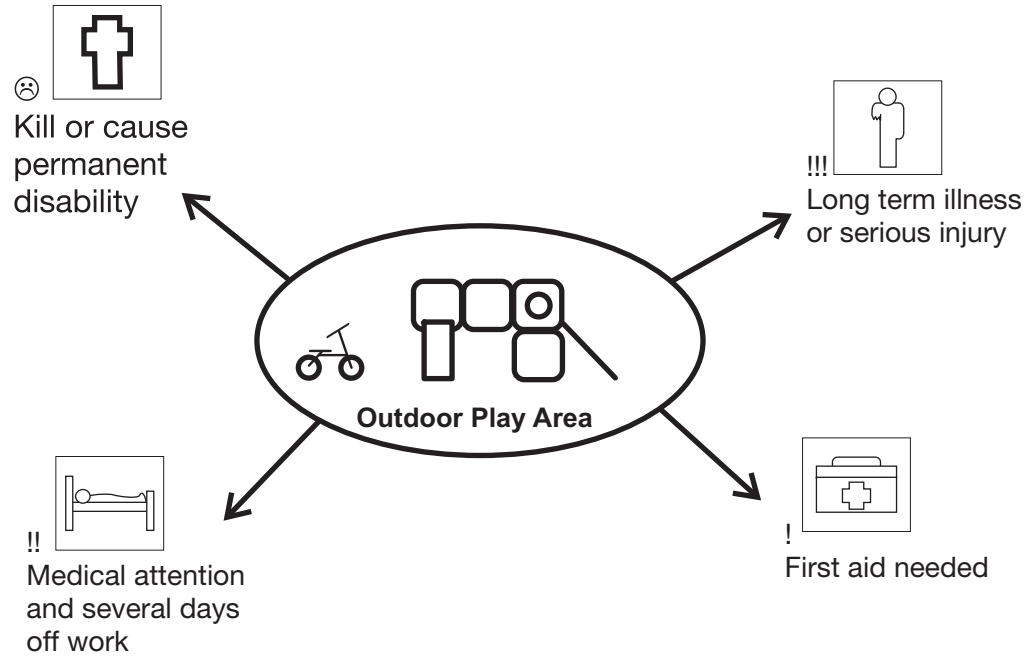

Remember
50-60%
of accidents
occur in the
out door play
area. Danger
time is between
3.00 -4.30pm.

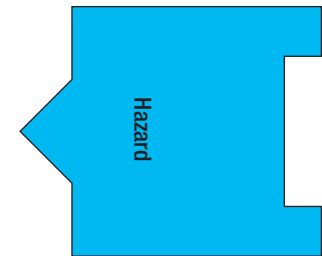

Be imaginative because anything is possible. Think of yourself as workers



children



families



others



Add the likelihood codes

++ very likely
could happen
any time

+ likely
could happen
sometime

- unlikely
could happen
but very rarely

-- very unlikely
could happen,
but probably
never will

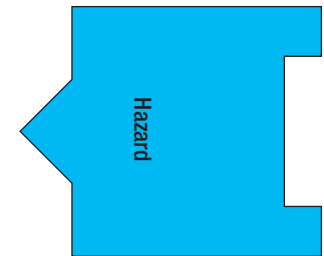
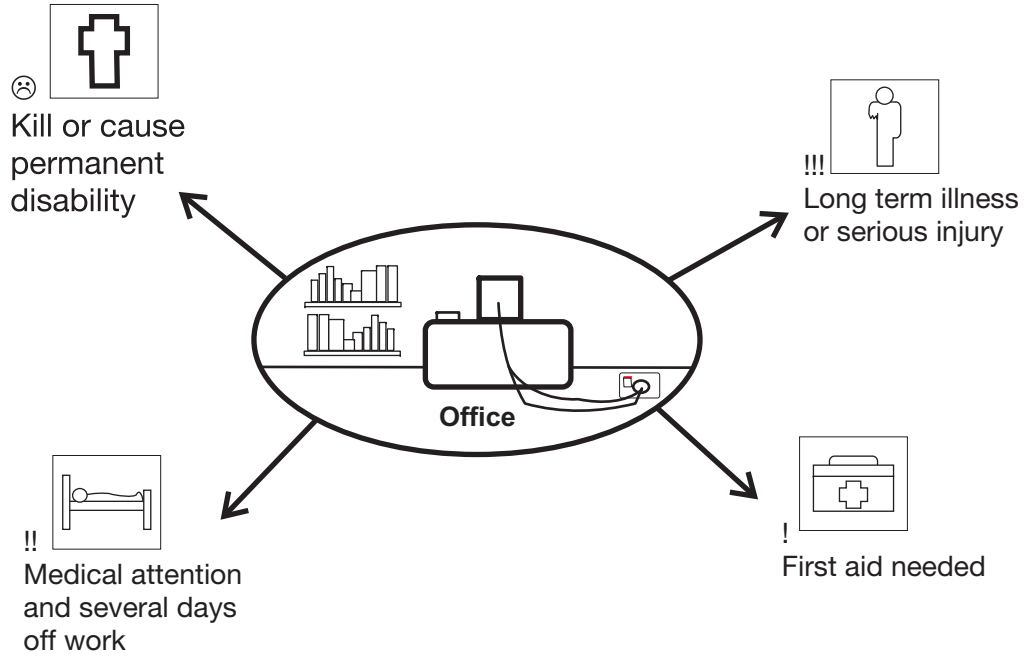



Add the likelihood codes

++ very likely
could happen
any time

+ likely
could happen
sometime

- unlikely
could happen
but very rarely

-- very unlikely
could happen,
but probably
never will

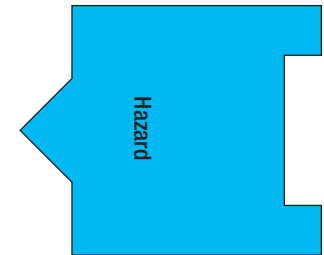
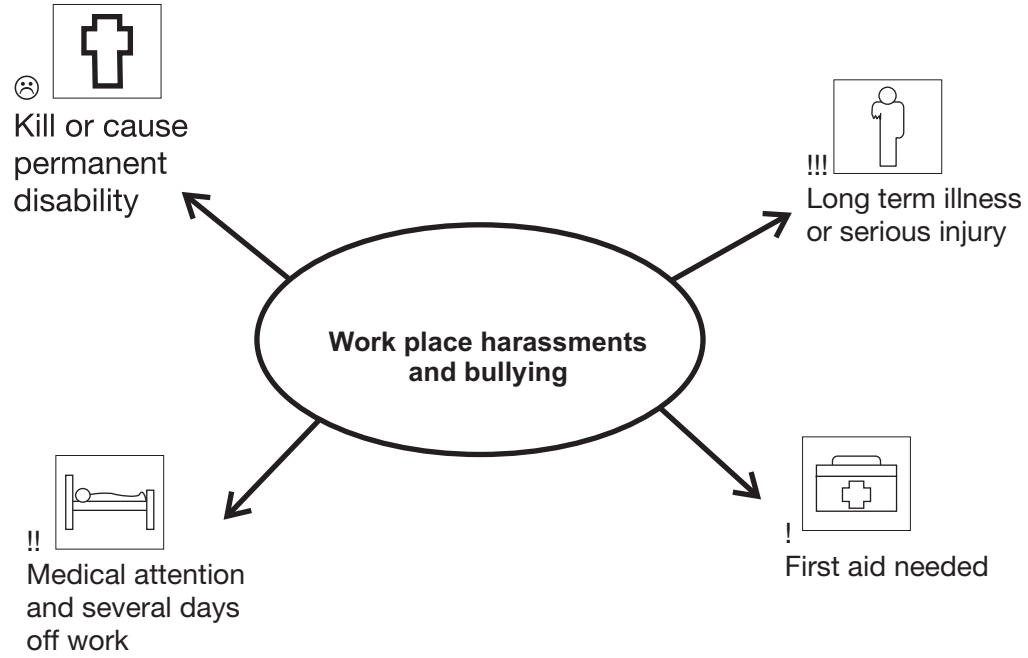

Be imaginative because anything is possible. Think of yourself as workers



children



families



others



Add the likelihood codes

++ very likely
could happen
any time

+ likely
could happen
sometime

- unlikely
could happen
but very rarely

-- very unlikely
could happen,
but probably
never will

